

BENEFITS

Highest Efficiency

SunPower™ Solar Panels are the most efficient photovoltaic panels on the market today.

More Power

Our panels produce more power in the same amount of space—up to 50% more than conventional designs and 100% more than thin film solar panels.

Reduced Installation Cost

More power per panel means fewer panels per install. This saves both time and money.

Reliable and Robust Design

Proven materials, tempered front glass, and a sturdy anodized frame allow panel to operate reliably in multiple mounting configurations.



SPR-320E-WHT-D



The planet's most powerful solar panel.

The SunPower™ 320 Solar Panel provides today's highest efficiency and performance. Utilizing 96 back-contact solar cells, the SunPower 320 delivers a total panel conversion efficiency of 19.6%. The 320 panel's reduced voltage-temperature coefficient, anti-reflective glass and exceptional low-light performance attributes provide outstanding energy delivery per peak power watt.

SunPower's High Efficiency Advantage

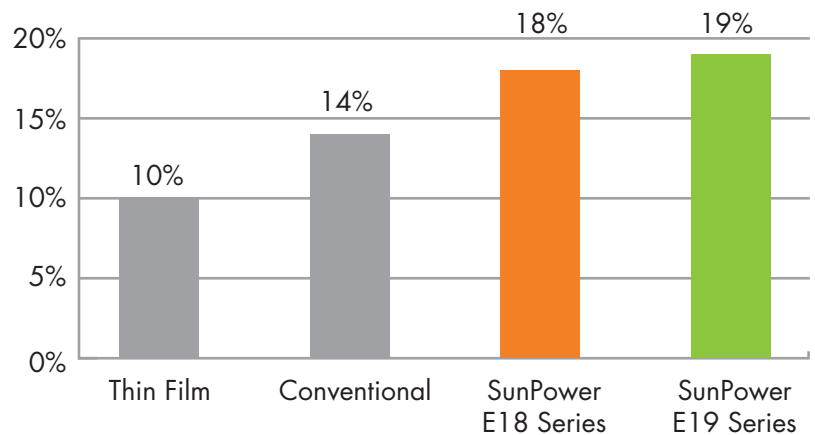

Electrical Data

Measured at Standard Test Conditions (STC): irradiance of 1000W/m², AM 1.5, and cell temperature 25° C

Peak Power (+5/-3%)	P _{max}	320 W
Efficiency	η	19.6 %
Rated Voltage	V _{mpp}	54.7 V
Rated Current	I _{mpp}	5.86 A
Open Circuit Voltage	V _{oc}	64.8 V
Short Circuit Current	I _{sc}	6.24 A
Maximum System Voltage	UL	600 V
Temperature Coefficients	Power (P)	-0.38% / K
	Voltage (V _{oc})	-176.6mV / K
	Current (I _{sc})	3.5mA / K
NOCT		45° C +/-2° C
Series Fuse Rating		20 A

Mechanical Data

Solar Cells	96 SunPower all-back contact monocrystalline	
Front Glass	High transmission tempered glass with anti-reflective (AR) coating	
Junction Box	IP-65 rated with 3 bypass diodes Dimensions: 32 x 155 x 128 (mm)	
Output Cables	1000mm length cables / MultiContact (MC4) connectors	
Frame	Anodized aluminum alloy type 6063 (black)	
Weight	41.0 lbs (18.6 kg)	

I-V Curve

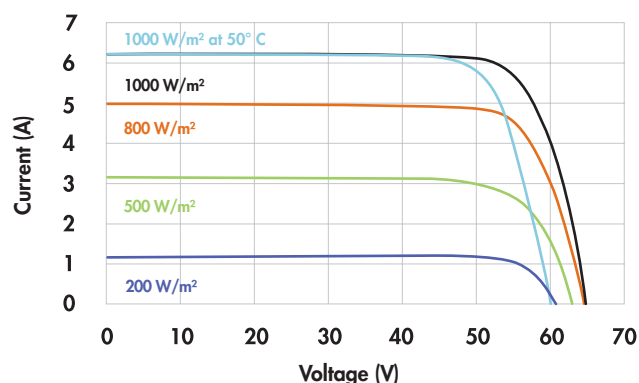

Tested Operating Conditions

Temperature	-40° F to +185° F (-40° C to + 85° C)
Max load	113psf 550 kg/m ² (5400 Pa), front (e.g. snow) w / specified mounting configurations 50 psf 245 kg/m ² (2400 Pa) front and back – e.g. wind
Impact Resistance	Hail 1 in (25 mm) at 51 mph (23 m/s)

Warranties and Certifications

Warranties	25 year limited power warranty 10 year limited product warranty
Certifications	Tested to UL 1703. Class C Fire Rating

Dimensions

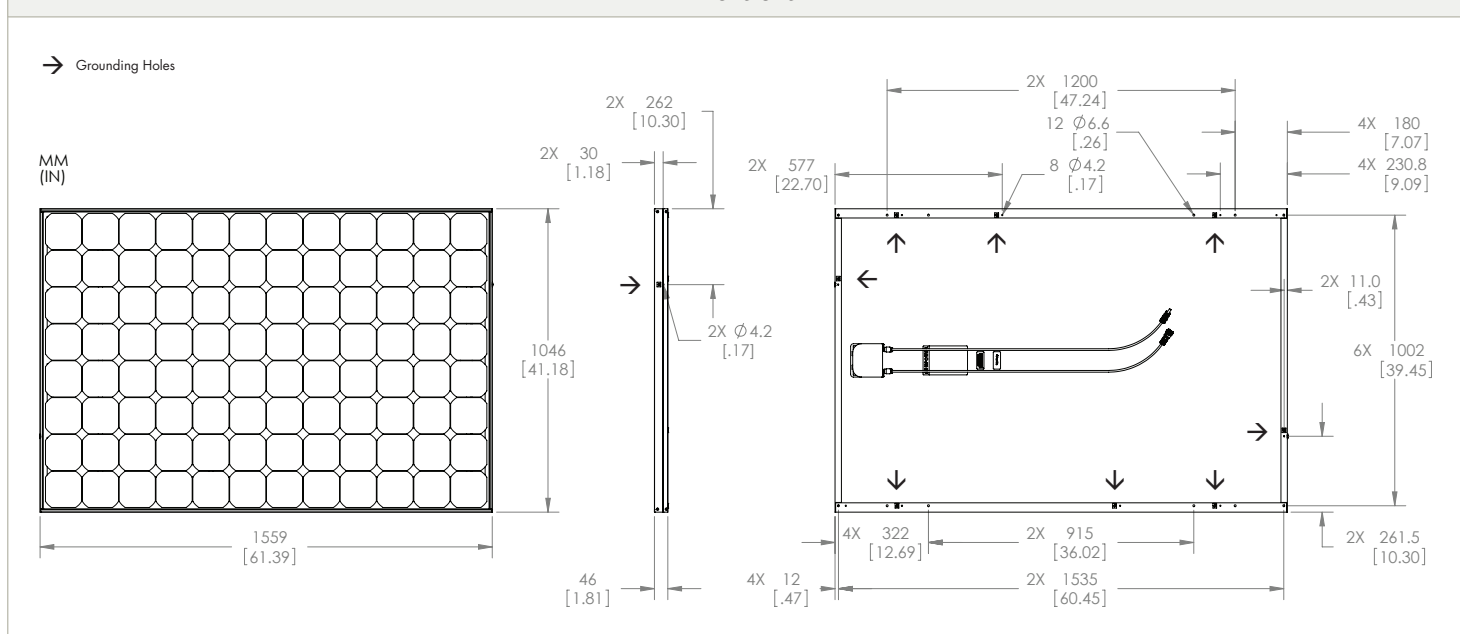

CAUTION: READ SAFETY AND INSTALLATION INSTRUCTIONS BEFORE USING THE PRODUCT.
Visit sunpowercorp.com for details